

# 65" 4K Slim Bezel Interactive Touch Displays



Interactive whiteboard solution for meeting rooms with integrated annotation and mirroring software

## Modern Interactive Whiteboard

The stylish enclosure design really makes this touch screen stand out from the crowd. The bezels are so thin that the display area occupies more than 91% of the overall screen size. Designed with aluminium bezels and a moulded polymer rear, the screen is so lightweight it can even be mounted on a stud wall.



- Slim Bezel
- Lightweight
- Matte Finish

## 4K Display

The 4K Ultra HD display delivers incredible image quality with four times resolution higher than Full HD. Optimised for viewing distances both near and far the display allows your content to take center stage for all your visual communication.

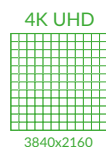

- 4K** 4K Display
- Boardroom Collaboration Tool
- Wireless Mirroring
- 5 Year On-Site Warranty\*
- Smart Pen
- Etched Anti Glare Glass
- 20 Touch Points
- Free Wall Mount
- Integrated Speakers
- Optional OPS PC
- Slim Bezel

\*(UK Mainland Only)

# Introducing MEETINGPAD: The Ultimate Collaboration Tool

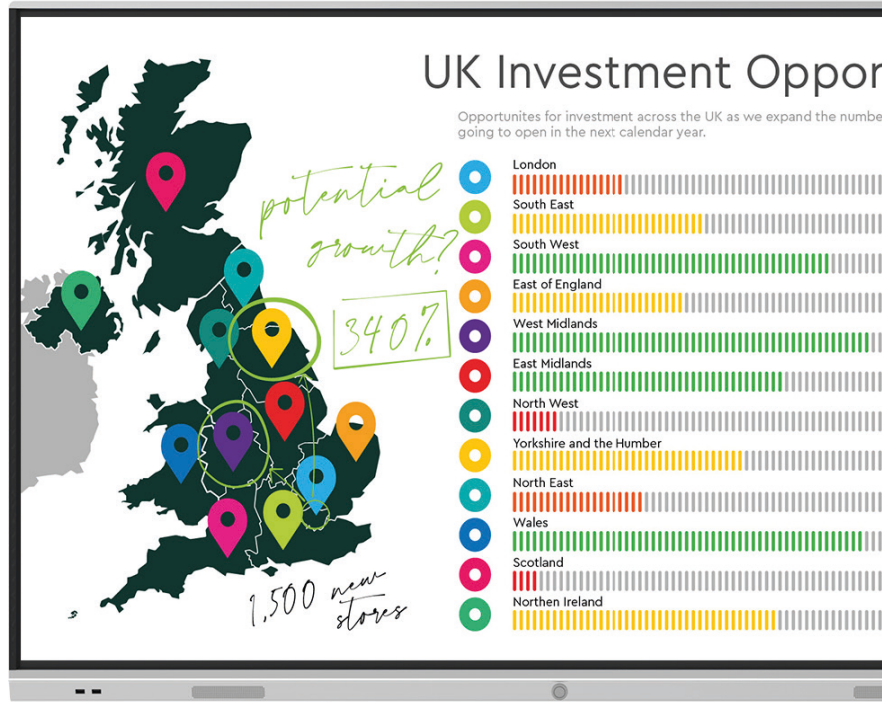

## Multi-Device Wireless Mirroring

Wirelessly project the displays of up to four smartphones, tablets, laptops, PCs or Macs. Using mobile devices you can mirror the display in both directions, and even take control of the touch screen. Mirroring via 5GHz allows for fast response, all without the need of external wires or transmitters.



## Easy File Sharing

Once your device is connected you can quickly and easily share documents, videos, images and audio files stored on your smartphone, tablet, laptop or PC directly to the touch screen. You can also share files from the touch screen to your device via email or by scanning a QR code with your mobile or tablet.



## Flexible Working Tools

Personalise your experience by changing the background colour of the display, as well as the colour and thickness of your drawing tools.



## Advanced Whiteboard Widgets

The screens feature advanced widgets for the whiteboard including a calendar, timer and a calculator. For drawing more technical diagrams there are rulers and compasses available. There are tools for temporarily hiding information from viewers with our spotlight and curtain widgets.



## Smart Pen Stylus

There are two stylish interactive 'Smart Pens' included. These special styluses allow you to control the display wirelessly from anywhere in the room. You can change the pen tool colour, save annotated documents, navigate through a PowerPoint presentation or website and go back to the 'MeetingPad' home screen.

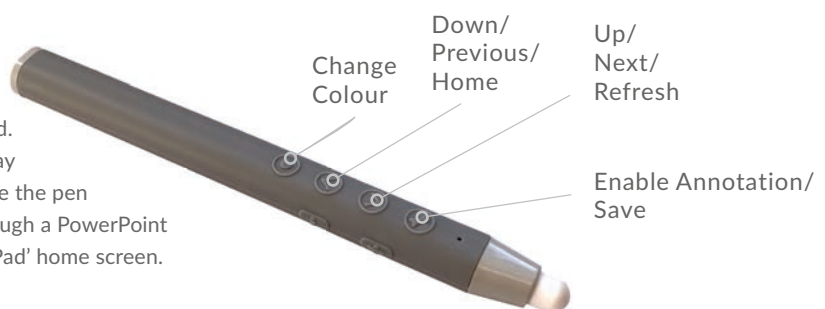

## Other Features

### Optional OPS Windows PC

For seamless integration onto existing networks an OPS PC can be installed into the rear of the display, allowing for ultimate flexibility to switch between Android and Windows effortlessly.



### Touch Screen Monitor

As well as using the built in Android system these displays can also be used as a touch screen monitor by connecting a PC or laptop via HDMI and USB.

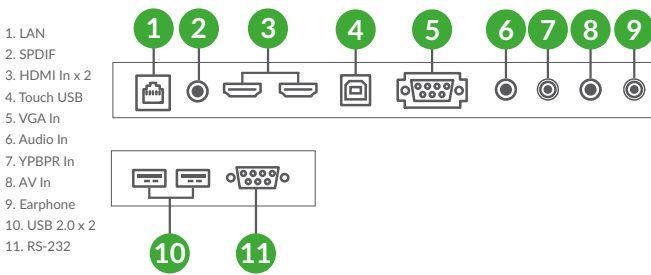

### Easy Access Ports and Controls

As well as having a power and standby button there are also two front facing USB ports. These are ideal for quickly and conveniently connecting USB sticks containing files that you need to access from MeetingPad or the optional OPS PC.



### Freeze Frame Function

While your laptop is connected you can freeze the image on screen so that you can continue to work independently on your laptop.

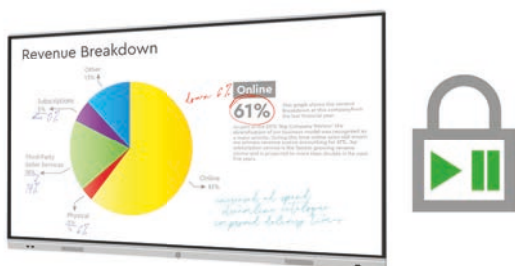

### 20 Touch Points

Ideal for large group collaboration, up to twenty users can interact with the screen simultaneously when working on group projects.



### Slim Bezel

The screens feature an extremely sleek and narrow bezel meaning that the enclosure to display area ratio is very low. The front is crafted from segmented aluminium to achieve ultimate precision while the polymer rear keeps the display super slim and lightweight.



### Etched Glass

Improves tactility for smoother touch gestures, especially useful for multiple users. The anti-glare nano coating also diffuses external light improving optical clarity.



### Integrated Speakers

The screens have two integrated super slim 10W speakers for presentations that include an audio element.





# Key Features



INTEGRATED ANDROID PC



20 POINT INFRARED TOUCH



ETCHED GLASS



SMART PEN STYLUS

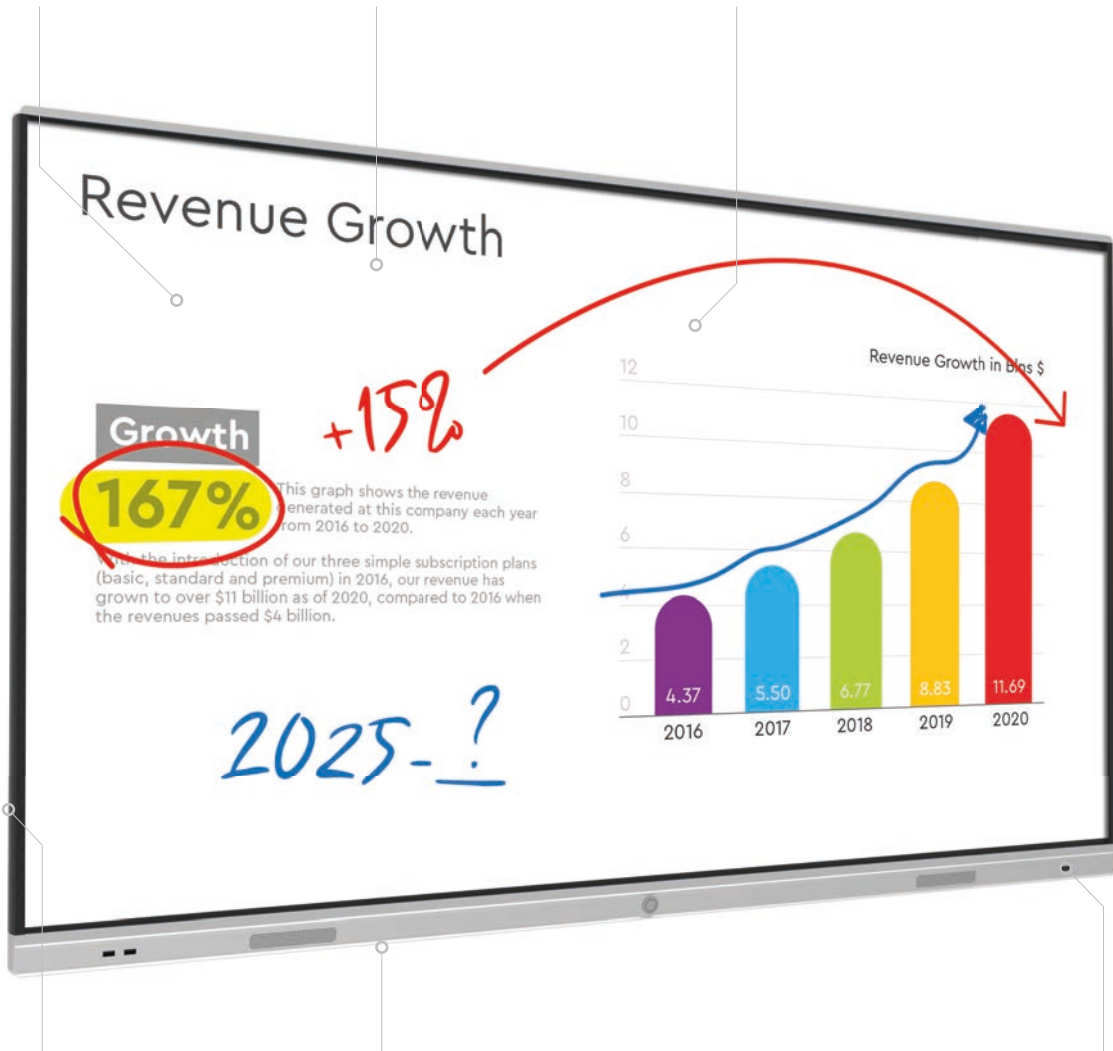

SLIM BEZEL



FREE WALL MOUNT



5 YEAR ON-SITE WARRANTY (UK MAINLAND ONLY)



EASY ACCESS PORTS AND CONTROLS

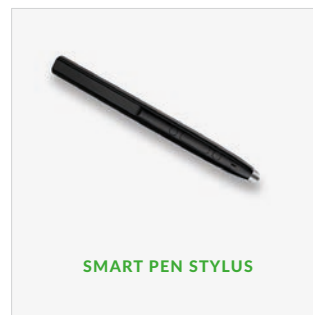
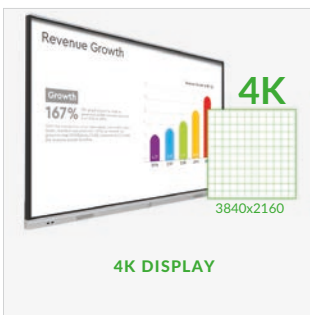

# Specification Table

		65 Inch
Panel	Resolution	3840x2160
	Display Area (mm)	1428x803
	Aspect Ratio	16:9
	Brightness (cd/m <sup>2</sup> )	500
	Colour	1.07G colors
	Colour Depth	8 Bit
	Viewing Angle	178°
	Contrast Ratio	1,200:1
	Lifespan	80,000 Hours
Touch	Touch Technology	Infrared
	Touch Points	20 (10 Touch Points in MeetingPad Software)
	Glass Thickness	4mm
	Response Time	≤8ms
	Touch Point Accuracy	±2mm
Audio	Speaker Type	2 x 12W
AV Ports	Front Ports	USB(2.0) x2
	Rear Ports	HDMI-In x2, USB(2.0) x2, Touch USB, Audio In, VGA, AV In, YPbPr, RS232, RJ45, Audio Out, Earphone Out
Power	Power Supply	AC110~240V (50Hz~60Hz)
	Power Consumption	130W
Mechanical	Unit Size (WxHxD mm)	1485x897.5x91.6
	Package Size (WxHxD mm)	1660x1047x220
	VESA Holes (mm)	500x400
	Net Weight (kg)	47.8
	Gross Weight (kg)	58.7
Environmental	Operating Temperature	-10°C to 50 °C
	Storage Temperature	-20°C to 60°C
	Operating Humidity	10% to 90%
	Storage Humidity	10% to 90%
Computer	CPU	Dual-Core A73 and Dual-Core A53 1.5GHZ
	RAM	3G
	Graphic Engine	G51MP
	Hard Drive/Internal Memory (eMMC)	32GB
	USB	USB 2.0 x2
	LAN	10/100 Ethernet
	Wi-Fi	2.4G/5G built-in Wifi
	OS	Android 8.0
Accessories	Included	User Manual (CD), Remote Control, Power Cable, 3m LAN Cable, 3m USB A Male to USB B Male Cable, 3m HDMI Cable, Wi-Fi Aerial (x3), Pointer, Magnetic Whiteboard Pen (x 2), Smart Pen (x1), Wall Mount
	Optional	Floor Stand/Trolley, Ceiling Mount, PushShare Dongle
Warranty	Warranty Period	5 Year Onsite Warranty (UK Mainland Only)
	Technical Support	Lifetime

Errors and omissions excepted



# Technical Drawing

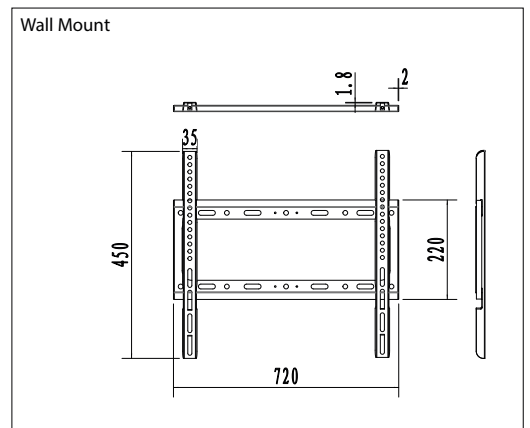
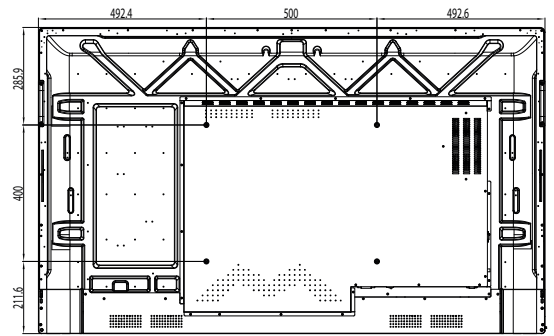
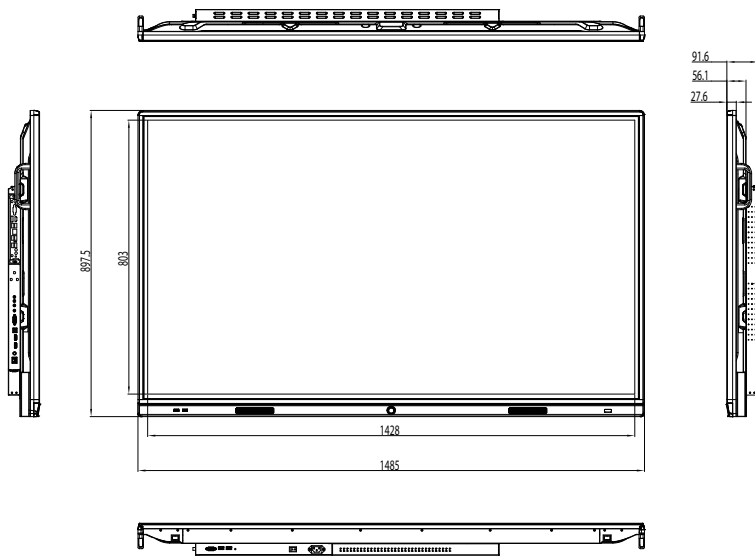

# Why Choose Our Commercial Display Solutions?



## Lifetime Technical Support

From the moment you receive your product, throughout the duration of your warranty and even after your warranty has expired we are here to support you. If you require any assistance setting up or using your product, or have any problems at all, we can provide free technical support via telephone and email.

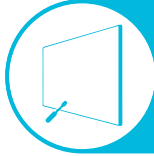

## On-site Support and Maintenance\*

If needed, we can provide an installation service for any of our products. We can also set up service-level agreements for larger projects that require maintenance contracts.



## Extended Warranty\*

All of our commercial display products come with a 3 year commercial warranty as standard but if you want to extend this you can upgrade this to cover a 5 year period at point of purchase.



## Training

As well as providing free remote CMS training sessions and webinars we can also visit you to deliver bespoke training for our software and hardware\*.



## Advanced Replacements†

Should your display suffer from any kind of hardware failure during the warranty period we will send you an advanced replacement and arrange for your old display to be collected, free of charge. This ensures no downtime where you are without a screen.



## Custom Product Testing & Configuration

If you need us to test third party software or a website, or configure your screen in a particular way before it is dispatched (e.g. in a particular orientation or network mode), we can do so to make your life easier.



## 3D Rendering

Want to know how a particular screen will look once installed? Send us a photo of the location and we will create a 3D rendering of any screen in situ to help you to visualise how amazing it will look.



## Logistics Support

We hold more stock in our UK warehouse than any other manufacturer so we can help you meet tight deadlines. For last minute orders we can also offer special express or morning delivery options\*. We also carry out UK based quality control checks on every display before it leaves our warehouse.



## Project Support

If you need to loan a sample unit to test we'd be more than happy to arrange this. We can also provide a rental service for temporary projects\*.



## Customisation\*

Your display can be customised to suit your requirements by adding your logo or printed graphics or even tailoring the colour of a display. We can also carry out hardware modifications to existing products or manufacture bespoke solutions for special projects.



## Extras\*

As well as being able to provide accessories and add-ons, such as extra remote controls, NUC PCs and video wall controllers, we can also supply custom made flight cases which are great if a display needs to be moved safely from place to place.

†UK mainland only

\*These particular services may incur additional charges